

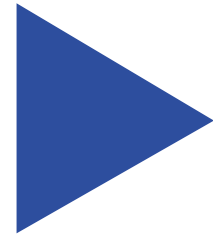

 **22ID5**



Foreword	4
Sharing information on office practices and statistics	5
Compilation of industrial design statistics	5
Development and maintenance of ID5 website	6
Recommended design practices	8
Catalogue of eligibility for industrial design protection	9
Analysis of underlying economic factors and IP office actions on how they impact global design filings	10
Industrial designs advancement and the ID5: a 5 year review	11
Joint communication action	12
The Hague Agreement on industrial designs	13
Study of priority document exchange by ID5 offices	13
Study on the admissibility of internet information as legitimate disclosure for novelty examinations	15
Study of quality management by ID5 offices	16
Promoting procedural frameworks aimed at protecting industrial designs	17
Study of design classification conventions and practices	17
Comparative study of practices concerning product indications	17
Catalogue of the view and drawing requirements for designs	18
Informative user guide for the view and drawing requirements for designs	19
Studies of the registration/examination practices of the Partner offices	20
Study of practices of priority right for industrial designs by ID5 offices	20
Comparative study of the application of a grace period for industrial design applications	21
Comparative study of partial designs as effective means of protection industrial design innovation	22
Study of design non-patent literature data resources among ID5 offices	23
A study of term of protection and the manner and framework for obtaining that term of protection for industrial design rights	24
Remedies and relief for industrial design infringement	25
Protecting emerging designs	26
Study of practices on protection of new technological designs	26
3D printing and industrial design protection	27
New technologies exchanges	28
LOOKING FORWARD	29

The 'ID5' is an Industrial design framework established in 2015, comprised of the China National Intellectual Property Administration (CNIPA), the European Union Intellectual Property Office (EUIPO), the Japan Patent Office (JPO), the Korean Intellectual Property Office (KIPO) and the United States Patent and Trademark Office (USPTO).

The ID5 Cooperation Forum strives at improving industrial design systems through greater awareness, improved work efficiency, increased quality and user-friendliness. It aims to do so by implementing common projects to promote the development of user-friendly, highly efficient and interoperable industrial design protection systems.

Over the past few years, the ID5 has lived up to its role as a catalyst for a modern international industrial design system. It has excelled in furthering the interests of global innovators who create industrial designs necessary for advanced technologies, systems, and products. At the same time, it has gone over and above expectations. The Partner offices have completed 16 projects and comparative studies. They have created reference materials for applicants, recommended design practices and joined together in a system that allows for priority documents to be shared among the Partner offices, electronically.

Given the leading role of ID5 members in IP matters – who together process and approve almost 90% of the world's design filings – the efforts of Partner offices are set to play a significant role in coordinating and nurturing innovation in industrial design in the years to come.

This document was compiled to present an overall look into the wide variety of projects undertaken by the ID5. This includes finalised projects and ongoing projects alike. Here we briefly detail the main aspects of each. The achievements have been structured around five main themes agreed on at the inception of the founding projects. The initiatives at the heart of these themes are aimed at advancing and modernising the industrial design system:

- 1. Sharing information on office practices and statistics**
- 2. The Hague Agreement on industrial designs**
- 3. Promoting procedural frameworks aimed at protecting industrial designs**
- 4. Studies of the registration/examination practices of the Partner offices**
- 5. Protecting emerging designs**

SHARING INFORMATION ON OFFICE PRACTICES AND STATISTICS



Compilation of industrial design statistics

Reason for the project:

To regularly exchange statistical data based on the indicators and to update or amend the indicators in order to more accurately capture the data that is of critical interest to the Partners and to then share the data with our users.

Deliverable:

Common statistical indicators to be shared once a year with the Partners and the public on the ID5 website. This will consist of up-to-date, accurate and useful [data](#).

Key Benefits:

- ▶ Determining statistical indicators which would most benefit users.
 - ▶ Discussing formulas/calculation methods for each indicator in order to make comparisons possible (as far as practicable).
 - ▶ Processing (including method and frequency) the statistical data exchanged with partners and shared with users.
- ▶ Led by JPO (2016 - ongoing)

NUMBER OF APPLICATIONS FOR DESIGN REGISTRATION OR DESIGN PATENT

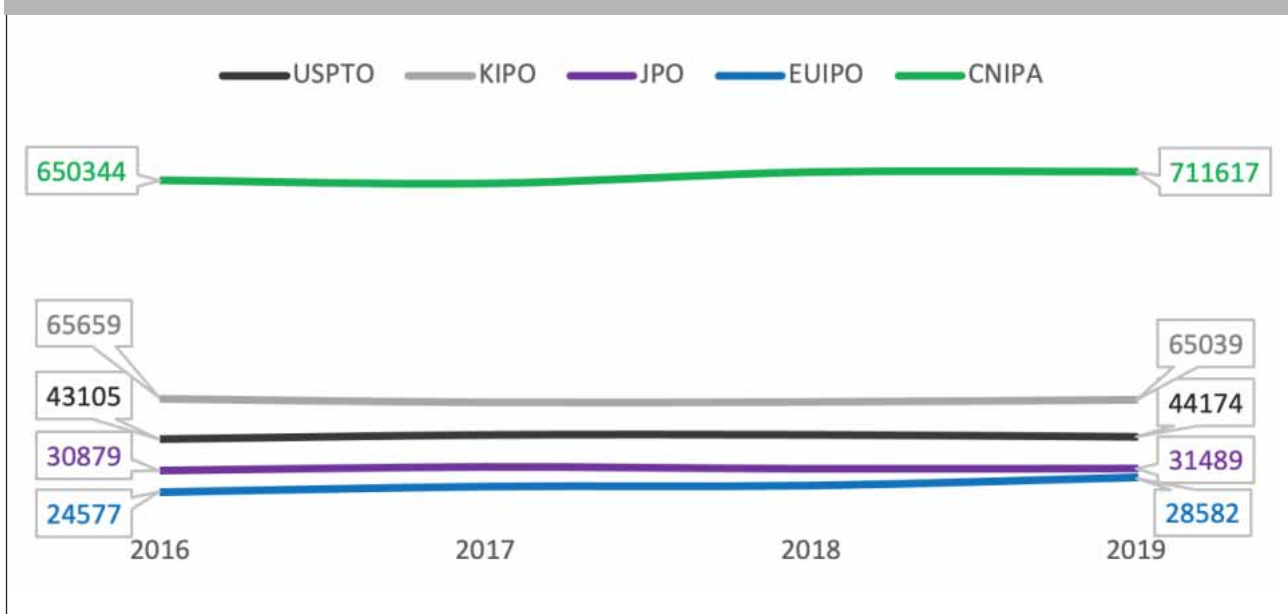



Development and maintenance of ID5 website

Reason for the project:

To develop and maintain a website in order to effectively share – with each other and with users – primary information concerning each Partner’s design regimes and shared priorities, as well as the details and progress of the various cooperation projects.

Deliverable:

[ID5 website](#), which should be both relevant and effective.

Key Benefits:

- ▶ Sharing information on each Partner’s design regimes.
 - ▶ Detailing the progress and results of cooperative projects.
 - ▶ Collecting users' opinions.
- ▶ Led by KIPO (2016 - ongoing)

DEVELOPMENT AND MAINTENANCE OF ID5 WEBSITE

Leading office
A KIPO

Due date
Fourth quarter of 2017

Purpose
To develop and maintain a website in order to effectively share – with each other and with users – primary information concerning each Partner’s design regimes and shared priorities, as well as the details and progress of various cooperative projects.

Desired outcome
The ID5 website has the goal of being the main channel to the public in order to share

Project Board for Development and Maintenance of ID5 Website

Number	Title
1	Get website development started

Project Board for Development and Maintenance of ID5 Website

ID5 Website Development(0831)

Author: User300 Date: 01/14/2016 12:14 Views: 2

If you have any opinion on this proposal, please reply it.
Thank you.

[Reply] : to write opinions

[Edit] or [Delete]

Like 0 Unlike 0

Attached file:

Like Reply Edit Delete

ID5 News

ID5	ID5 Joint Message for World Intellectual Property Day 2022	April 26, 2022
ID5	2021 ID5 Annual Meeting Brochure	April 13, 2022
ID5	Publication of the Study of design Non-Patent literature data resources among ID5 Offi...	December 19, 2021
ID5	Publication of ID5 Catalogue of Quality Services Involving Users	December 19, 2021

ID5 News and latest news articles of each Office

News | Recently updated

CNIPA	IP publicity week highlights protection and innova...	
EUIPO	Webinar: Drugs: accepted principles of morality under Article 7(1)(f) EUTMR	May 06, 2022
JPO	PPH between the Japan Patent Office (JPO) and the Eurasian Patent Organization (EA...	May 10, 2022
KIPO	Result of KIPO's Enforcement Activities on Counterfeit Goods in 2021	February 23, 2022
USPTO	Remarks by USPTO Director Kathi Vidal at PPAC	May 10, 2022
WIPO	Hague System: Morocco Joins the Geneva Act of the Hague Agreement	May 11, 2022

ID5 CONTACT | Latest Post Notification

© 2017 ID5. All rights reserved.

CNIPA

EUIPO

JPO

KIPO

USPTO

Introduction

The ID5 is an industrial design framework comprised of China National Intellectual Property Administration (CNIPA), the European Union Intellectual Property Office (EUIPO), the Japan Patent Office (JPO), the Korean Intellectual property office (KIPO) and the United States Patent and Trademark Office (USPTO). Considering the value and the significance of industrial design in global and domestic markets, and its expanding role in innovation;

Project Briefs

Informative User Guide for the View and Drawing Requirements of Designs | Lead by CNIPA & EUIPO

The project aims to form an easy to read guide based on the previous EUIPO led project of Catalogue of the View and Drawing Requirements for Designs, and it will present ...

A Study of Term of Protection and the Manner and Framework for Obtaining that Te... | Lead by USPTO

References

CNIPA	Law & Regulations Examination Standards Classification Fee Schedule Statistics	EUIPO	Law & Regulations Examination Standards Classification Fee Schedule Statistics
JPO	Law & Regulations Examination Standards Classification Fee Schedule Statistics	KIPO	Law & Regulations Examination Standards Classification Fee Schedule Statistics
USPTO	Law & Regulations Examination Standards		

Introduction of ID5

Project Titles and the Lead Offices

Industrial Design Information of Each Office



Recommended design practices

Reason for the project:

To produce an agreed set of recommended but non-binding provisions on recommended design practices endorsed by the ID5 Partners.

Deliverable:

A finalised 'Recommended Design Practices' [document](#) to be shared with the public.

Key Benefits:

- ▶ Providing support for certain design formalities that have long been discussed in international forums as best practices.
- ▶ Contributing to the advancement of the global design system and design formalities practices for the benefit of users and offices alike.
- ▶ Led by USPTO & JPO



Recommended Design Practices

Disclaimer: While the ID5 is composed of the Partner IP Offices of CNIPA, EUIPO, JPO, KIPO and USPTO, the *Recommended Design Practice Articles* set forth herein were developed by the JPO, KIPO and the USPTO. Due to institutional competencies of other agencies within their respective governments, CNIPA and EUIPO refrained from participating in this particular project. Non-participation by the offices of CNIPA and EUIPO should not be interpreted either as providing opposition or support to any of the subject matter contained herein.

Catalogue of eligibility for industrial design protection

Reason for the project:

To broaden the mutual understanding among Partners through the sharing of basic legal information, such as information on design protection systems and eligibility requirements.

Deliverable:

A [catalogue of eligibility](#) for industrial design protection.

Key Benefits:

- ▶ Collating the various legal definitions of what constitutes a design; collating information about the subject matter of

design protection and the registrability / patentability requirements for design protection. Also, establishing what the criteria are for a design to be considered in accordance with each ID5 Partners' respective legislation.

- ▶ Comparing the registrability/patentability requirements of each Partner.
- ▶ Analysing basic legal information on the Partners' respective design systems, including the legal definitions of a design, and the subject matter of design protection.
- ▶ Led by KIPO (2016 - 2018)

GRAPHICAL USER INTERFACE ON A DISPLAY*

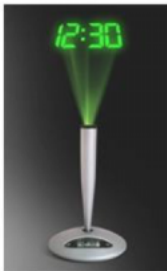
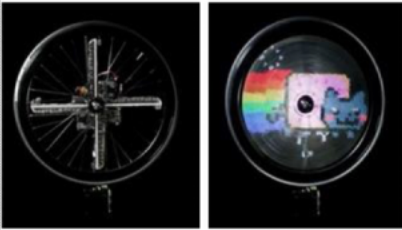
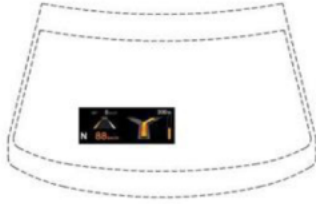
Example : items not recognized as an article			Example : items recognized as an article
			
"keyboard"	"watch"	"bicycle wheel"	"vehicle front glass panel in which GUI is indicated"

**The eligibility for design depends on the specific law of each partner*



The Japan Intellectual Property Association (JIPA) is grateful for the work done so far in ID5. With regard to the ID5's objectives of 'providing improved services to users and the public', we have witnessed the improvement in the quality of examinations and services through the promotion of research projects related to these objectives. The ID5 has also been successful as a forum regarding the exchange of information on practices and has been very beneficial to users. We believe that the cooperation of the ID5 offices and the participation of users in each country will continue to lead to the development of the industry and the formation of a better society. ”

JIPA



Analysis of underlying economic factors and IP office actions on how they impact global design filings

Reason for the project:

To assess and describe the impact of the underlying economic drivers and IP-related events on the evolution of the number of design applications received by the respective ID5 IP offices.

Deliverable:

A [report](#) analysing the underlying economic factors and IP office actions and how these impact global design filings.

Key Benefits:

- ▶ Collating data on design applications, information about events and actions

undertaken by Partners that could have been the drivers for an increase in applications received. Collating information on other events that may have been behind an increase/decrease in applications received.

- ▶ Increasing knowledge on the factors that drive demand for design applications in the various offices analysed. This allows for more efficient planning, budgeting and organisation, and helps improve the IP offices' forecasting.

▶ Led by EUIPO (2016 - 2019)

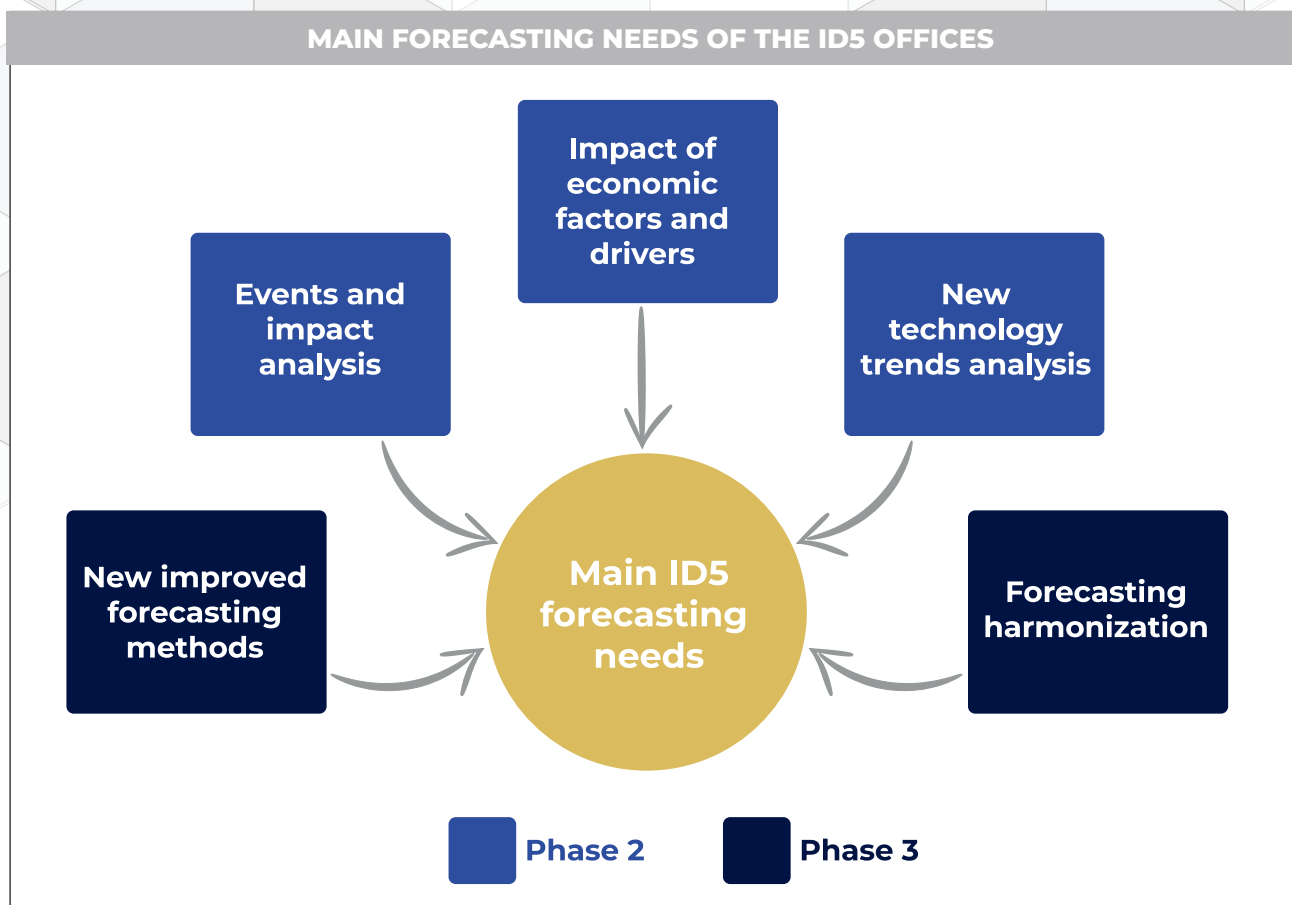



Industrial designs advancement and the ID5: a 5 year review

Reason for the project:

To identify, compile and highlight areas that the ID5 jurisdictions have been able to make progress in. This is aimed at meeting stakeholders' needs and overcoming international challenges.

Deliverable:

A high-level survey aimed at gathering information on the most significant changes in the legal framework and practice of each of the ID5 offices in the area of industrial design protection and filing practices over the last 5 years.

Key Benefits:

- ▶ Providing transparency as to the progress made in advancing the global design system where this can be directly or indirectly attributed to each office's participation in the ID5 industrial design forum. This is aimed at ensuring that the data provided through previous ID5 projects is still accurate and reliable.
- ▶ Giving the ID5 partners the opportunity to identify previous projects that may need to

be updated to reflect changes in law and practice. This is aimed at ensuring that the information provided by the ID5 is accurate.

- ▶ Led by USPTO (2020 - ongoing)

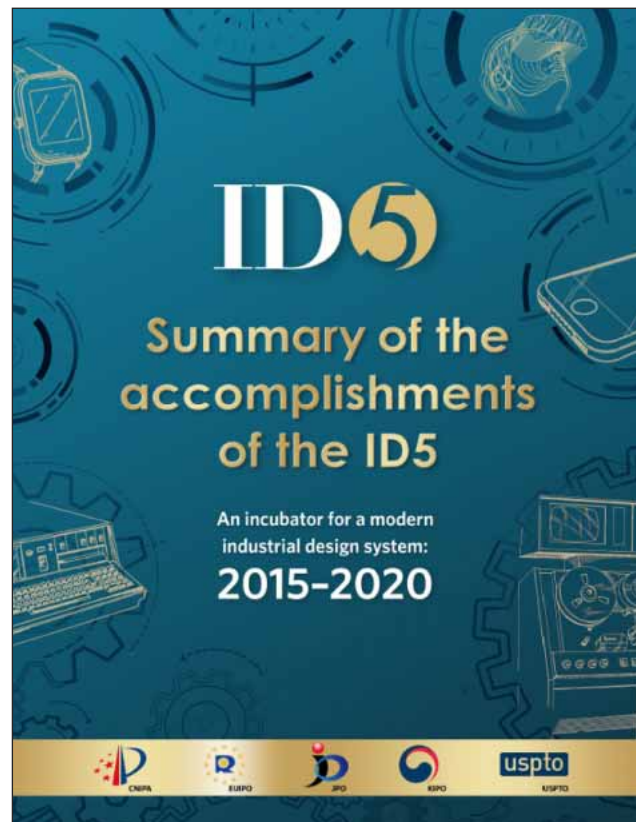

The ID5 offices annually receive approximately 90% of all global industrial design filings. Accordingly, their participation in ID5 projects is highly valuable to applicants and practitioners, and user groups appreciate their important study projects, culminating in reports on fundamental topics such as drawing requirements, prior art, partial designs, new technological designs, and product indication, all of which serve to inform stakeholders and illuminate paths for harmonization. AIPLA thanks you for developing and publishing these practical resources.

AIPLA



Joint communication action

Reason for the project:

To share information on communication practices and strategies among the ID5 partners and to identify potential opportunities to communicate to the public about the ID5 forum.

Deliverable:

Sharing information on the communication practices and strategies among the ID5 partners and agreeing on joint communication actions.

Key Benefits:

- ▶ Identifying communication opportunities and developing actions that are beneficial for the ID5 partners in the most cost-effective way.
- ▶ Sharing information concerning each Partner's design regimes as well as details on the progress of cooperative projects.
- ▶ Implementing specific actions oriented to foster awareness on the aims, activities, upcoming news and events of ID5 as well as to disseminate the project outcomes and results to a large audience.
- ▶ Led by EUIPO & KIPO (2020 - ongoing)

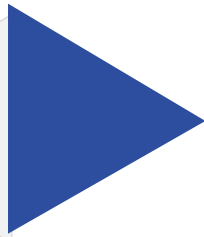

THE HAGUE AGREEMENT ON INDUSTRIAL DESIGNS

Study of priority document exchange by ID5 offices

Reason for the project:

To determine the feasibility of implementation timelines for Partners joining the WIPO Digital Access Service (DAS)-based priority document exchange system and/or CNIPA's Verifiable Priority Document (VPD) system.

Deliverable:

A [priority document exchange system](#) as a channel for exchanging industrial design priority documents, thus providing more choice and better services to users in keeping with the aims of ID5, including improving the user-friendliness of industrial design systems.

Key Benefits:

- ▶ Identify systems which may facilitate an efficient and accurate exchange of priority documents for industrial designs (e.g., WIPO DAS and VPD).
- ▶ Develop a format and structure for a feasibility study and implementation timelines.
- ▶ Identify Partners in a position to join the industrial design priority certification system(s).
- ▶ In 2020, all ID5 Offices had successfully joined WIPO DAS to facilitate an efficient and accurate exchange of priority documents for industrial designs.

▶ Led by CNIPA & USPTO (2016 - 2021)

ID5 MEMBERS AS DEPOSITING OFFICE (OFF) AND ACCESSING OFFICE (OSF) TO EXCHANGE INDUSTRIAL DESIGN PRIORITY DOCUMENTS AMONG ID5 PARTNERS USING WIPO DAS

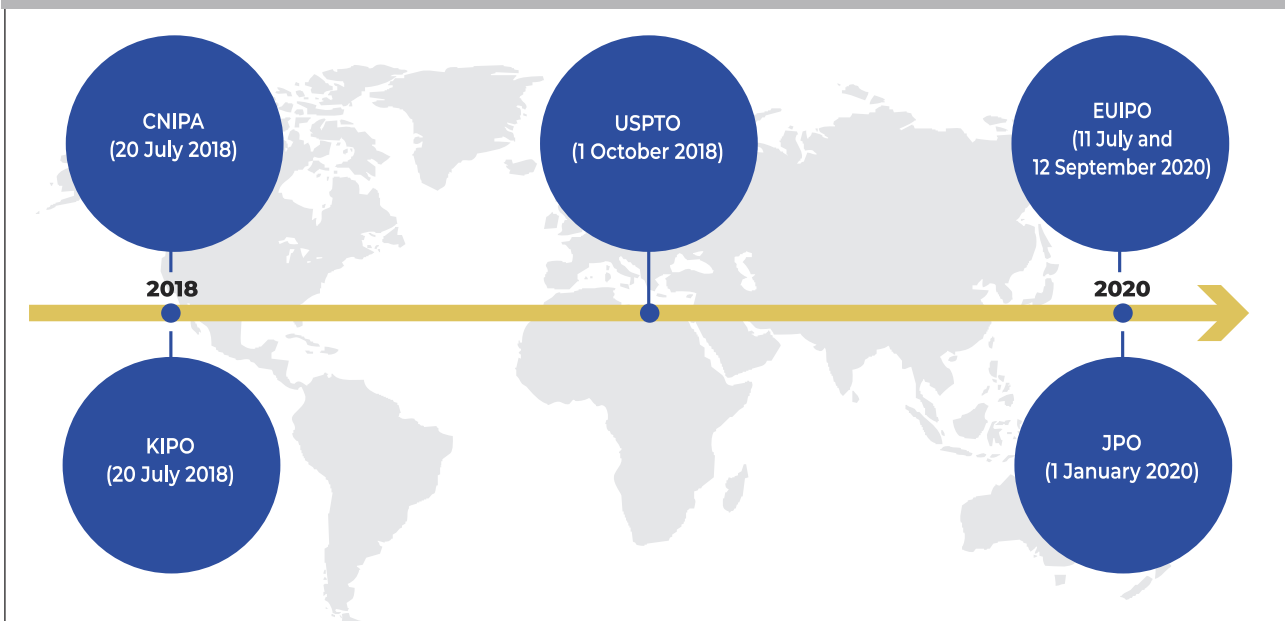

ID5 AS OFF SENT DOCUMENTS

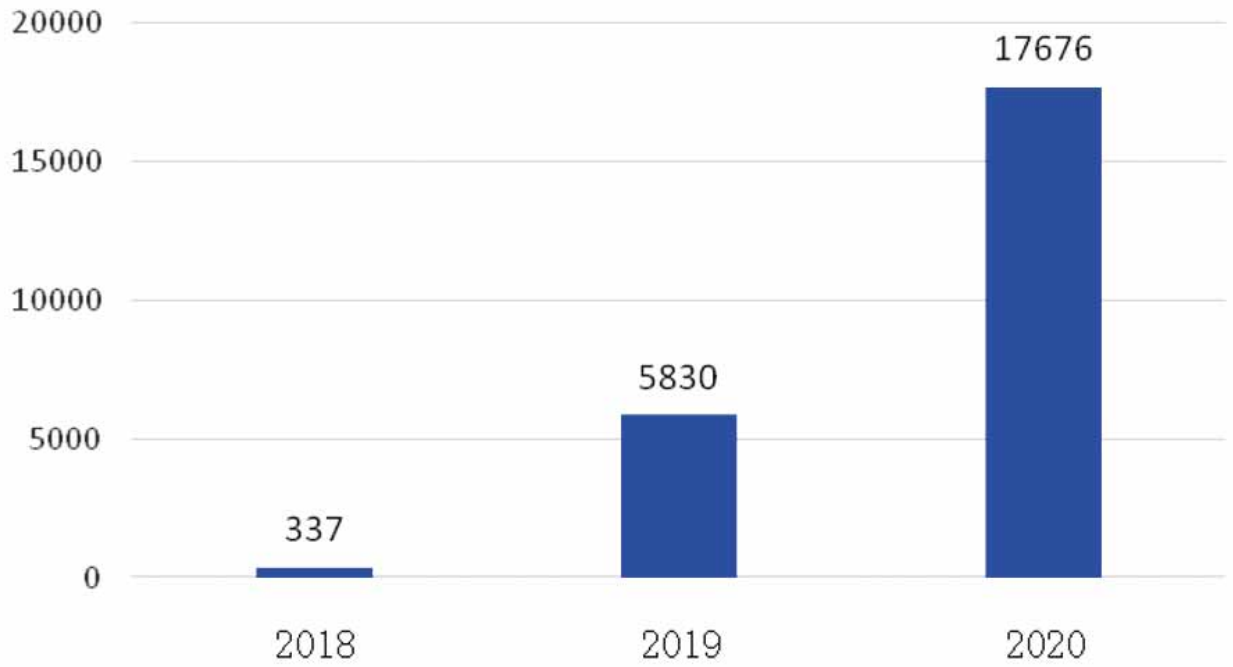

ID5 AS OSF RECEIVED DOCUMENTS

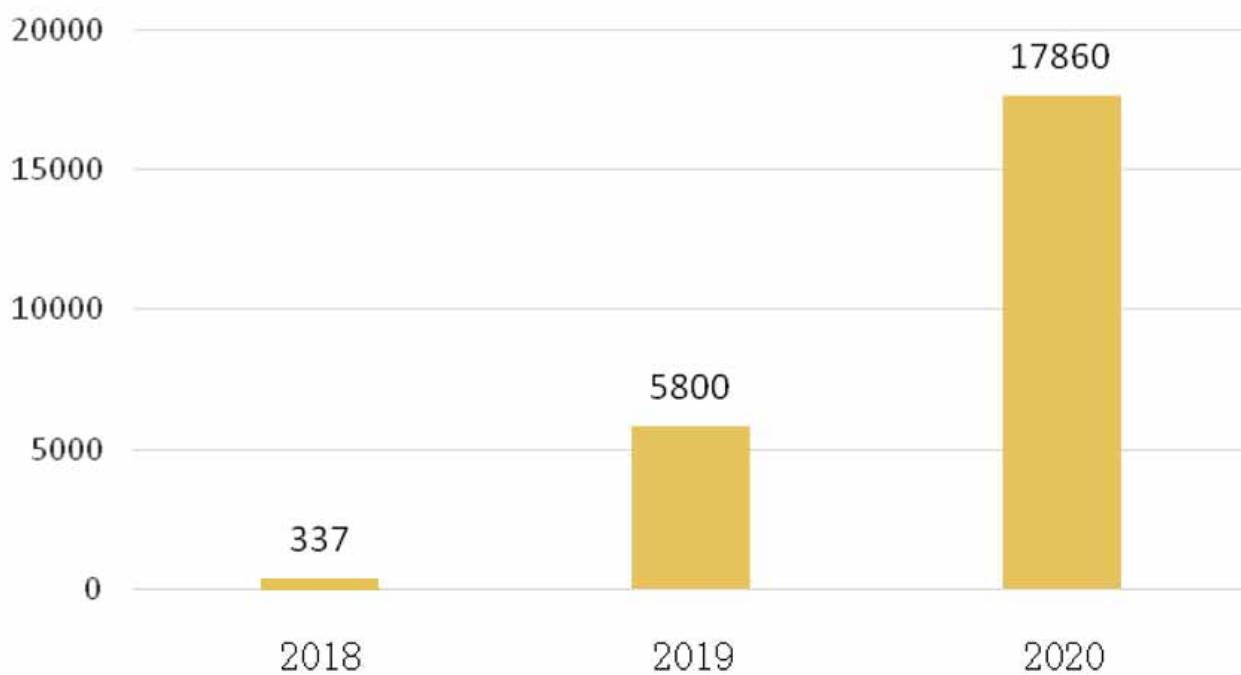



Study on the admissibility of internet information as legitimate disclosure in novelty examinations

Reason for the project:

Sharing outcomes with users or conducting further study on the design information available on the Internet that be handled in novelty examinations. Such design information available on the Internet has the general nature of irregular frequency of publication and updating, and the published information may also be easily deleted or modified afterwards.

Deliverable:

[Study on the admissibility](#) of internet information as a form of legitimate disclosure for novelty examinations.

Key Benefits:

- ▶ Deepening mutual understanding of the practices in handling Internet information in novelty examinations.
- ▶ Sharing useful information on the validity, effectiveness and lack of security of information sourced from the Internet for the purposes of examination.
- ▶ Providing users with a more stable and secure environment for design protection.

- ▶ Led by JPO & CNIPA



Study on the Admissibility of Internet Information as Legitimate Disclosure for Novelty Examinations



Study of quality management by ID5 offices

Reason for the project:

To exchange information regarding quality management initiatives between the five partner offices and to identify quality initiatives with user involvement. This is to promote the mutual understanding and common progress of the ID5 offices and to provide users with a high quality product and better service.

Deliverable:

A [study of quality management](#) by the ID5 offices. "ID5 Catalogue of Quality Services Involving Users" giving users a systematic overview of the services and initiatives offered by each office.

Key Benefits:

- ▶ Advancing a mutual understanding and mutual trust of the quality offered by the ID5 offices.
- ▶ Providing a reference point for the ID5 offices to promote quality management.
- ▶ Improving users' confidence and satisfaction in the products and services offered.

- ▶ Lead by CNIPA & EUIPO (2018 - 2021)

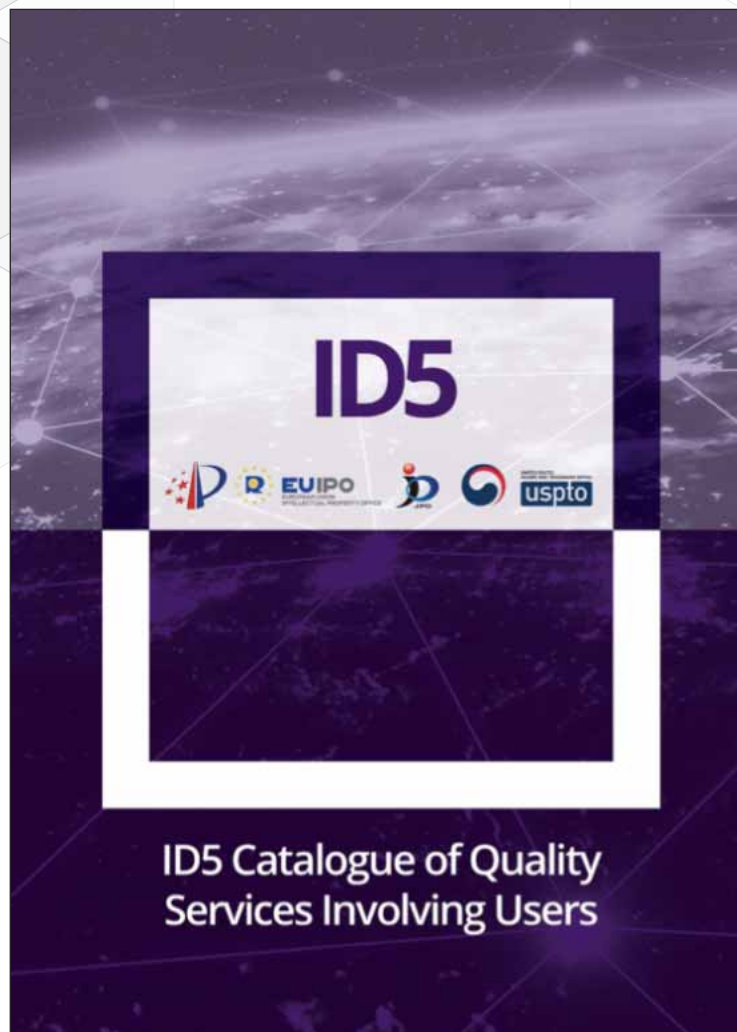

PROMOTING PROCEDURAL FRAMEWORKS AIMED AT PROTECTING INDUSTRIAL DESIGNS



Study of design classification conventions and practices

Reason for the project:

To work for a mutual understanding by collating and organising the information about each ID5 office's respective design classification systems and operations and to then share these with the Partners.

Deliverable:

A [research study report](#) which compares the design classification system and proceedings by each Partner.

Key Benefits:

- ▶ Sharing information regarding the various design classification systems and procedures.
- ▶ Comparing the design classification system and procedures run by each Partner. This is to be prepared in such a way (in format and structure) that it can easily be identified and shared.

- ▶ Led by JPO & KIPO (2016 - 2017)



Comparative study of practices concerning product indications

Reason for the project:

To allow a better understanding of the differences among the practices of the ID5 Offices concerning product indications for the benefit of the offices and their users.

Deliverable:

A [comparative study of practices](#) concerning product indications .

Key Benefits:

- ▶ ID5 partners will have a better mutual understanding of each ID5 office's practice on product indications.
- ▶ Sharing compiled information with users.

- ▶ Led by EUIPO (2016 - 2019)



Catalogue of the view and drawing requirements for designs

Reason for the project:

Comparison of the legal provisions and practices of the ID5 Offices as regards the graphical representations of industrial designs.

Deliverable:

[Catalogue of the view and drawing requirements](#) for designs.

Key Benefits:

- ▶ Comparing the legal provisions and guidelines of the Partners as regards the graphical representations of industrial designs.
- ▶ Enlarging, completing and updating the knowledge of each Partner about the view and drawing requirements of the other Partners.
- ▶ Exchanging best practices among the Partners.
- ▶ Led by EUIPO (2016 - 2017)

VARIOUS WAYS OF PRESENTING A DESIGN

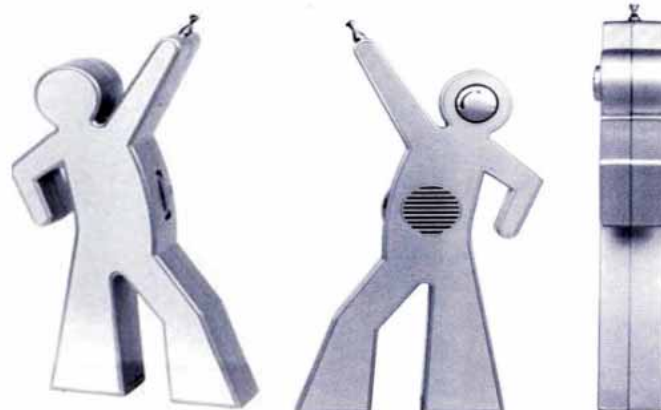



Informative user guide for the view and drawing requirements for designs

Reason for the project:

To create an easy-to-read guide based on the previous EUIPO-led project for the creation of a 'Catalogue of the View and Drawing Requirements for Designs'. The User Guide is to be presented to users in an easy-to-follow format by highlighting the differences and similarities concerning the view submissions to the five offices.

Deliverable:

An informative User Guide for the View and Drawing Requirements of Designs.

Key Benefits:

- ▶ Enhancing users' understanding of the product views to be submitted to the five offices and providing users with important and easy-to-follow reference materials.
- ▶ Increasing mutual understanding of the requirements of each of the offices through cooperation.
- ▶ Led by CNIPA & EUIPO (2021 - ongoing)



As approximately 80% of international applications from Korea are concentrated in the CNIPA, the EUIPO, the JPO and the USPTO (according to the WIPO statistics in 2020), Korean users are keen to the policy directions and changes of the ID5 Offices.

In that sense, the outcomes of the joint projects conducted by the ID5 every year enhance our understanding of the systems of the member Offices, and thereby helping us secure global designs but also identify the issues of interest to those Offices.

It is our hope that the ID5 will continue to be a collaborative forum that provides users with more opportunities for active participation and engagement. On behalf of Korean users, KINPA would like to thank ID5 for its joint achievements and efforts. ”

KINPA

STUDIES OF THE REGISTRATION / EXAMINATION PRACTICES OF THE PARTNER OFFICES

Study of practices of priority right for industrial designs by ID5 offices

Reason for the project:

To better understand the differences, via an in-depth comparative study on foreign priority rights systems for industrial designs. This is in order to increase the knowledge of, and to update, each Partner about foreign priority rights laws and to explain the practices in other countries.

Deliverable:

A comparative [study of foreign priority systems](#) for industrial design to enhance communication and mutual trust among ID5 offices and to make the [application process](#) easier and more effective for users.

Key Benefits:

- ▶ Enabling applicants to apply for a national industrial design while claiming the benefit of the filing date of an earlier foreign application, thus making it easier to obtain protection for the same design in different countries.
- ▶ Allowing a comparison of the differences in the laws and practice on the foreign priority right systems among ID5 offices.
- ▶ Enabling partners to understand the standards in regard to the foreign priority right system.
- ▶ Led by CNIPA (2016 - 2018)





Comparative study of the application of a grace period for industrial design applications

Reason for the project:

To catalogue and compare the provisions related to a grace period for industrial designs for each of the Partners, and study how the grace period is applied in each of the respective jurisdictions.

Deliverable:

[Comparative study](#) of the application of a grace period for industrial design applications.

Key Benefits:

- ▶ Helping identify what practices and requirements the Partners have in common and where divergences still exist.
- ▶ Comparing the Partners' legal provisions, rules, regulations and guidelines and whether there is a grace period for industrial designs.
- ▶ Led by JPO & USPTO (2016 - 2018)

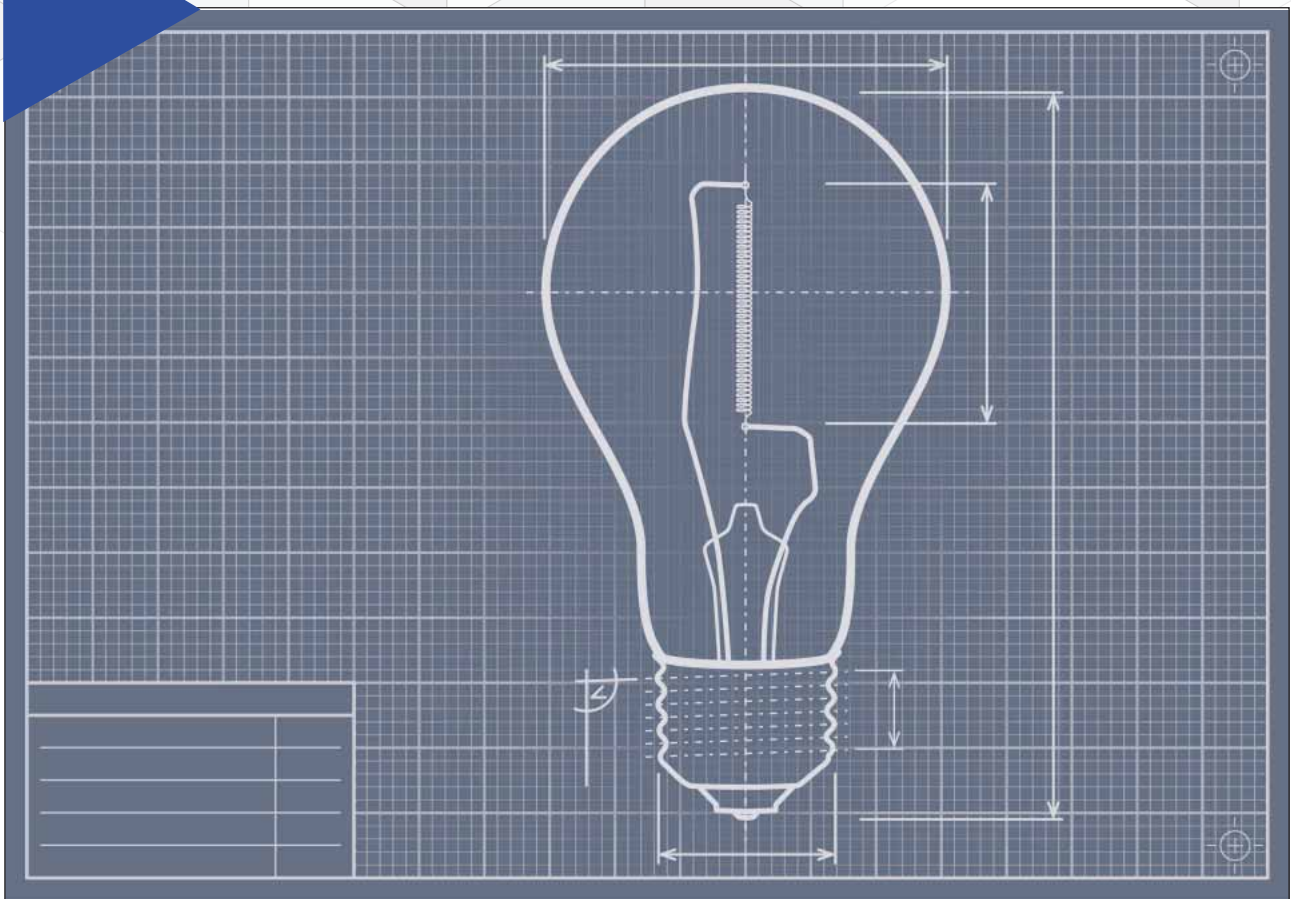



Comparative study of partial designs as an effective means of protection for industrial design innovation

Reason for the project:

To catalogue and compare the provisions related to the protection of partial designs for each of the Partners (i.e., a design for less than the entire article/product), including the use of broken lines and other depiction methods.

Deliverable:

A comparative [study of partial designs](#) as an effective means of protection for industrial design innovation.

Key Benefits:

- ▶ Making it easier to identify the requirements and practices which are shared by the Partners and other requirements and practices where divergences exist.
- ▶ Comparing the legal provisions, rules, regulations and guidelines of the Partners related to the protection of partial designs.
- ▶ Led by JPO & USPTO (2016 - 2018)

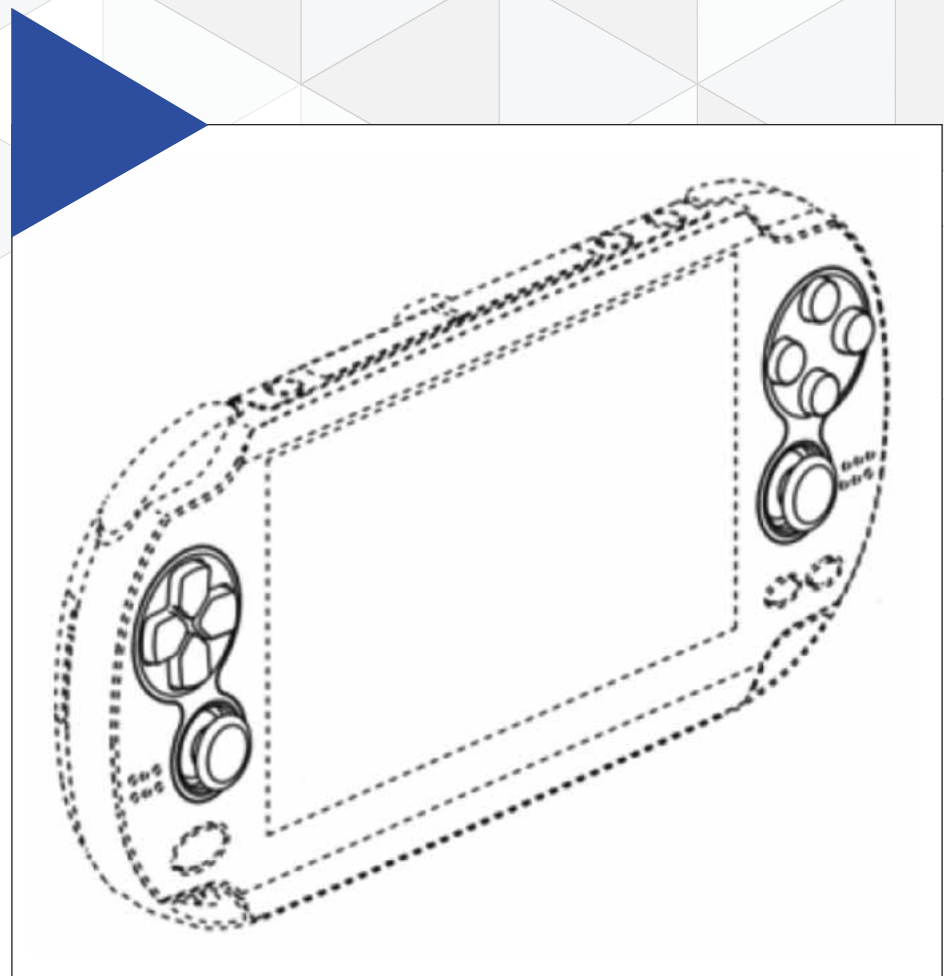

*Design Registration
No. 673478 (portable
information terminal,
Sony Interactive
Entertainment Inc.)*



Study of design non-patent literature data resources among ID5 offices

Reason for the project:

Information sharing and comparative study of design non-patent literature data resources among the five partner offices. The study will involve aspects like collecting the scope and methods, processing, saving, maintaining as well as applying design non-patent literature data.

Deliverable:

[Report containing information of design non-patent literature data resources](#), application status, matters of common concern for the five offices, including best practice of interpreting information available on the Internet.

Key Benefits:

- ▶ Enhancing mutual understanding and trust among the five partner offices.
 - ▶ Clarifying design non-patent literature data resources of the five offices, especially the application status of Internet data resources.
 - ▶ Promoting learning between partner offices by sharing practical experience and best practices.
- ▶ Led by CNIPA & JPO (2018 - 2021)





A study of term of protection and the manner and framework for obtaining that term of protection for industrial design rights

Reason for the project:

To compare the provisions and different practices related to the various terms of protection for industrial designs.

Deliverable:

The creation of a catalogue of the existing scope of legal frameworks and the office practices used to protect industrial designs.

Key Benefits:

- ▶ Enlarging, completing and updating the knowledge of each Partner about provisions

related to the protection of industrial designs in each of the Partner jurisdictions.

- ▶ Helping to increase the legal certainty on design protection.
- ▶ Identifying where legal frameworks and office practices meet user needs to protect industrial design and identifying where legal frameworks and office practices could potentially be enhanced.

- ▶ Led by USPTO (2020 - ongoing)



Remedies and relief for industrial design infringement

Reason for the project:

To give an overview of the available remedies and relief for industrial design infringement for each of the Partners, and how this remedy/relief is determined.

Deliverable:

A study providing an overview of the available remedies and relief available for industrial design infringement for each of the Partners, and how this remedy/relief is determined.

Key Benefits:

- ▶ Creating opportunities for an increased understanding of the subject area and more legal certainty for industrial design protection across the Partner Offices.
 - ▶ Creating reference material for users through the publication of the study.
 - ▶ Enhancing and updating the knowledge of each Partner about the remedies and relief structures available for industrial design infringement.
- ▶ Led by USPTO & KIPO (2020 - ongoing)



As a national organization focusing on Intellectual Property in China, Patent Protection Association of China (“PPAC”) and our members greatly appreciate the cooperation on Industrial Design (“ID”) of the five offices. The ID5 cooperation brings users not only the outcomes of the ID5 projects, but also the insights of ID operation from the offices’ view, which we think is truly beneficial. With the further cooperation of the offices, as well as the closer participation of the industry, we believe the ID5 cooperation will achieve the common goals of the offices to promote the development of more user-friendly, highly efficient and interoperable ID systems. ”

PPAC

PROTECTING EMERGING DESIGNS



Study of practices on protection of new technological designs

Reason for the project:

To promote the protection of emerging designs by comparing the existing provisions and different practices among the ID5 Offices related to the protection of new and emerging industrial designs and identifying gaps in existing protection and office practices.

Deliverable:

[Cataloguing the existing scope of the legal frameworks and office practices](#) used to protect identified emerging designs. Considering potential improvements and developments to the existing legal frameworks and office practices that were identified in the catalogue.

Key Benefits:

- ▶ Creating a catalogue of the existing scope of legal frameworks and office practices used to protect identified emerging designs.
 - ▶ Collaborating on future projects, designed to bridge identified gaps in existing legal framework and office practices.
 - ▶ Monitoring the development of new types of emerging designs for potential consideration by the Partners in future. These would benefit both users and the offices alike.
- ▶ Led by EUIPO & USPTO (2016 - 2018)

COMPARISON OF REFUSALS BASED ON DISTINCTIVENESS

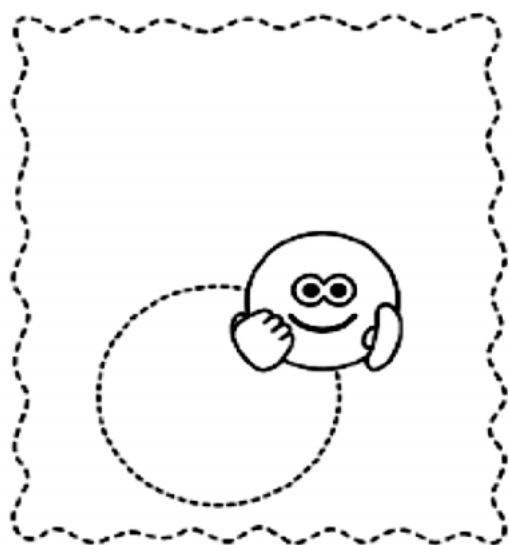

FIG. 1

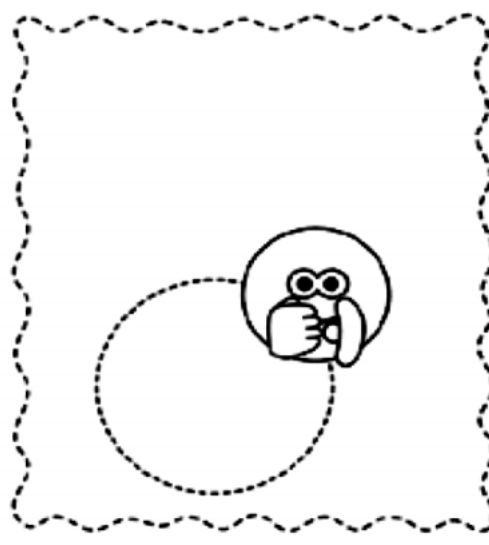

FIG. 2



3D printing and industrial design protection

Reason for the project:

To understand the need to cooperate when protecting future designs in the rapidly changing trading environment by examining design infringement issues in relation to the increasingly rapid spread of 3D printers.

Deliverable:

A [report](#) on whether 3D printable files are included in the definition of an industrial design and whether there is a need for increased cooperation amongst the ID5.

Key Benefits:

- ▶ Helping users understand the scope of industrial design protection for each of the Partners concerning design infringement caused by 3D printing. This was done by looking into contentious industrial design protection issues related to 3D printing.
- ▶ Determining the importance of collaboration amongst ID5 partners regarding the matter of 3D printing and industrial design protection
- ▶ Led by KIPO (2018 - 2019)

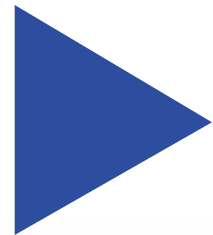



New technologies exchanges

Reason for the project:

To provide a platform for the ID5 partners to exchange information and experience about the use of new technologies. The Partners do this by sharing information on new technology IT solutions for design examination that can be used to streamline examinations.

Deliverable:

ID5 partners sharing their experiences about the use of new technologies.

Key Benefits:

- ▶ Presenting new initiatives for the partner offices to consider in the fields of new technology solutions, such as Artificial Intelligence and Blockchain.
- ▶ Sharing information on new IT solutions for design examination that can be used to streamline examination. This is done by improving the efficiency of IT systems.
- ▶ Led by EUIPO (2020 - ongoing)

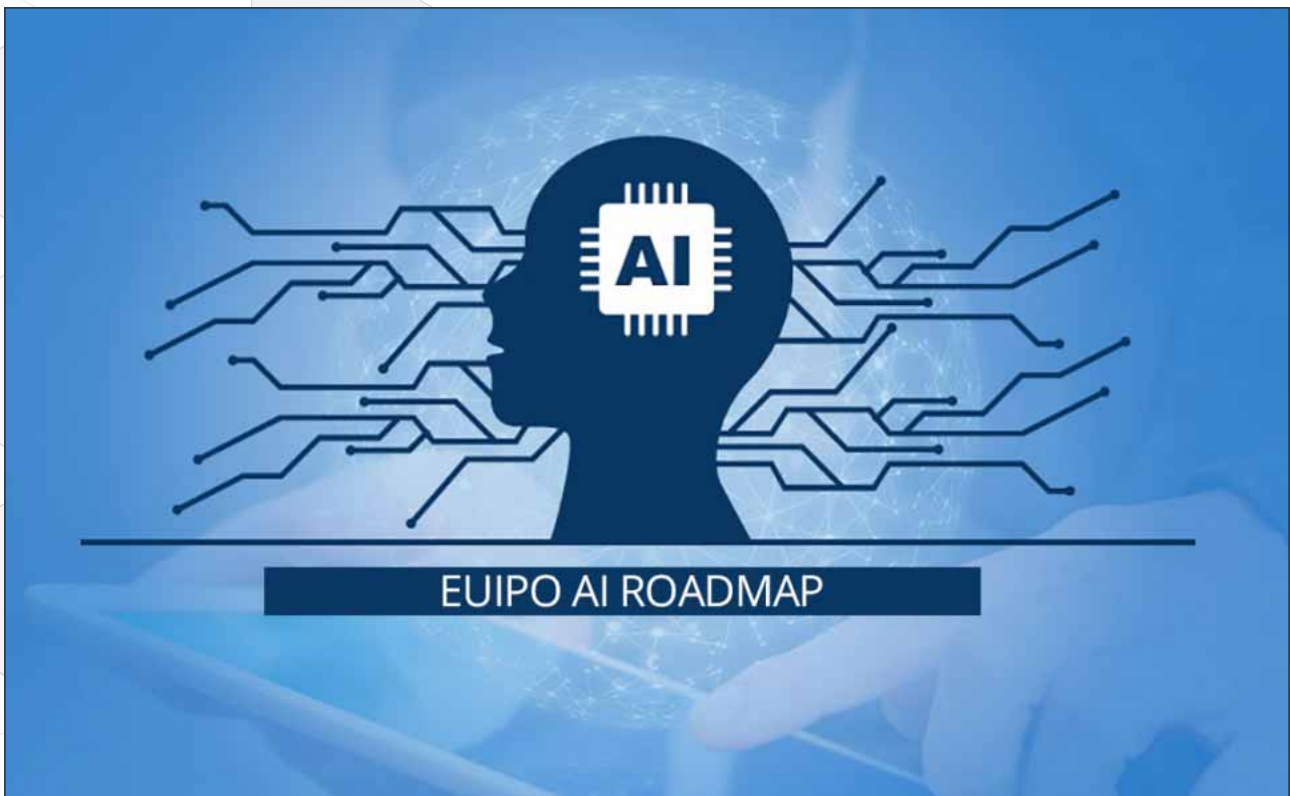

“BUSINESSEUROPE congratulates the ID5 for its achievements during the past 7 years. BUSINESSEUROPE highly supports harmonisation projects in the field of designs, which certainly benefit European businesses active in the five biggest design jurisdictions. In the future, it is key that ID5 continues delivering good results, and that joint ID5 projects and initiatives are user-driven.”

BUSINESSEUROPE

LOOKING FORWARD

Building on this progress and these achievements Partners are set out to work towards:

- ▶ A highly functioning industrial design protection system that is adaptable to changing design landscapes and changing need of users, particularly relating to digital and new emerging technologies;
- ▶ Enhancement of interoperability among various operating practices and procedures amongst the Partners including through the Hague system or through possible convergence of practices;
- ▶ Joint efforts in providing reliable and high-quality services for users;
- ▶ Broader cooperation with a wide group of users, raising awareness of the tools and benefits made available by the ID5's cooperative efforts.







22ID5

id-five.org

